

COALBROOK

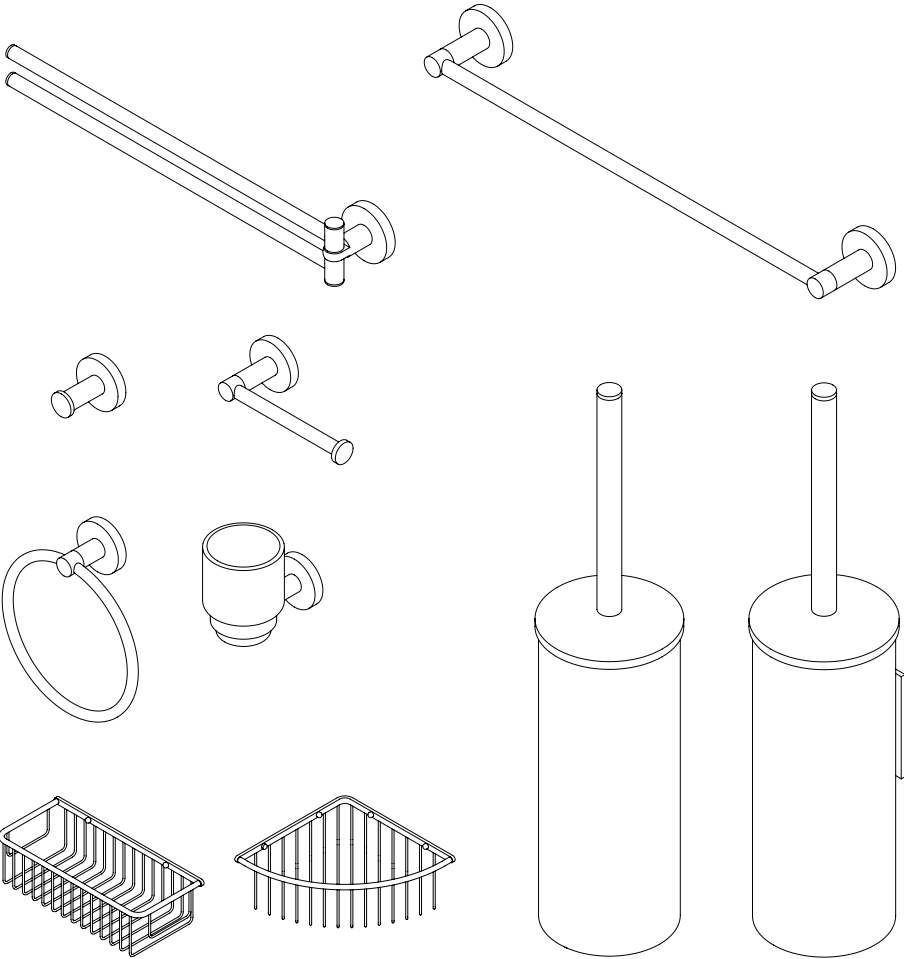

ACCESSORIES INSTALLATION

DO7000 - 7009

HOLDER INSTALLATION

DO7003

DO7002

DO7008

DO7006

DO7000

DO7005

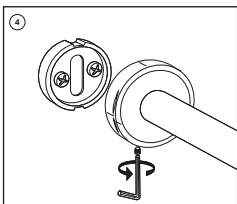
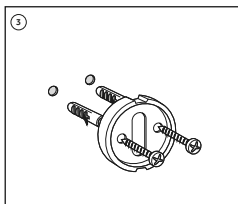
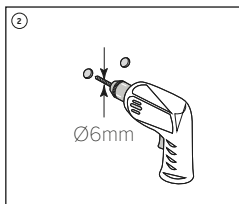
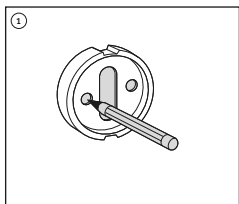
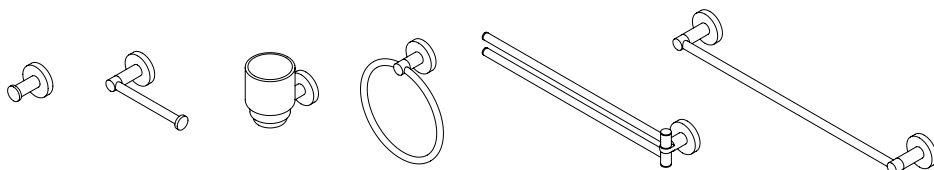

BASKET INSTALLATION

DO7004

DO7007

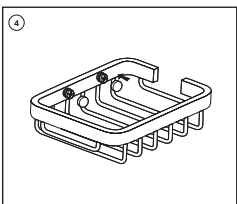
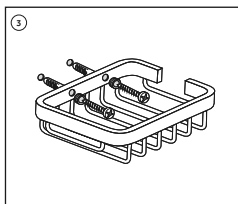
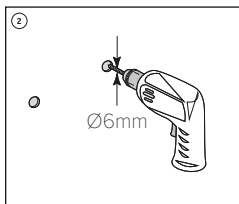
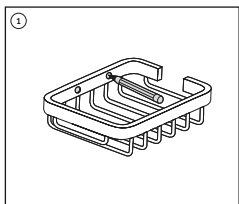
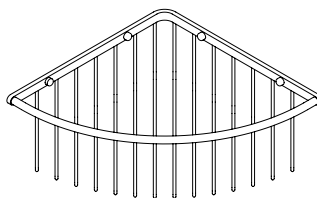
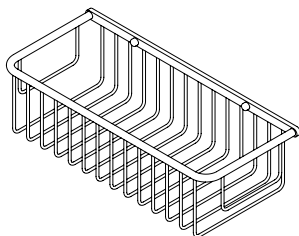

COALBROOK

TOILET BRUSH HOLDER INSTALLATION

DO7009

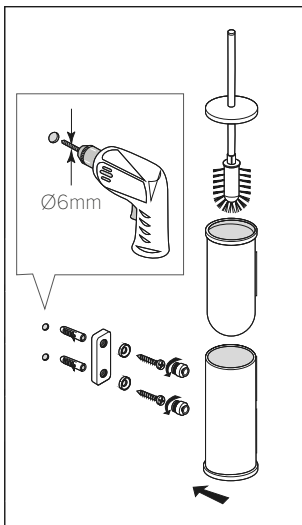
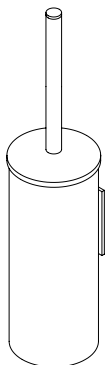

DO7001

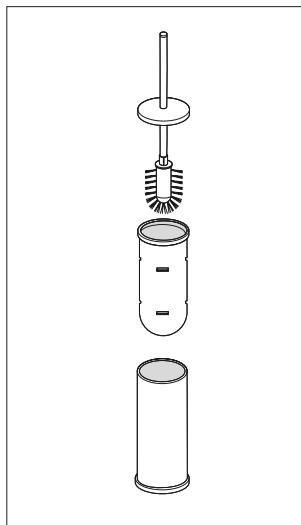
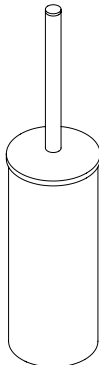

COALBROOK



COALBROOK

Whilst every effort is made to ensure the accuracy of these, they are subject to change without notice as part of the company's product development process. The use of trademarks, product design and artwork is subject to licence or agreement. The design registrations, trademark registrations and copyrights are protected by law and the use or reproduction outside the terms of an agreement is prohibited.

The right to modify designs and dimensions is reserved. E & O.E.

COALBROOK

www.coalbrookuk.co.uk | info@coalbrookuk.co.uk