

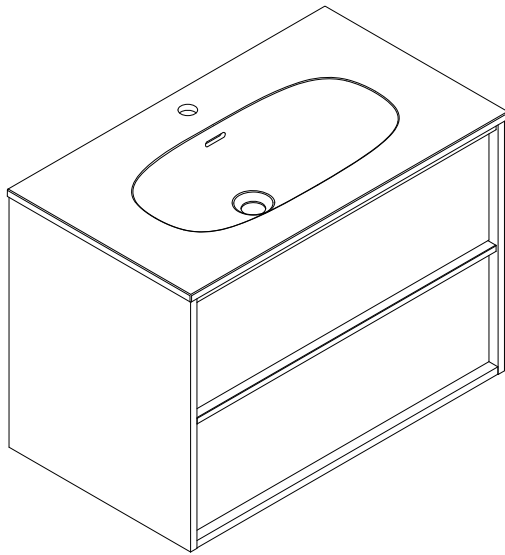

COALBROOK



INSTALLATION & AFTERCARE GUIDE

FURNITURE



INSTALLATION GUIDE

04 Introduction Installation Guide

05 Aftercare Guide

06 Cloakroom Vanity Units

08 Tall Units

10 Short Projection Units

12 500 - 1200mm Vanity Units

14 LED Strip Lighting

BATHROOM FURNITURE INSTALLATION

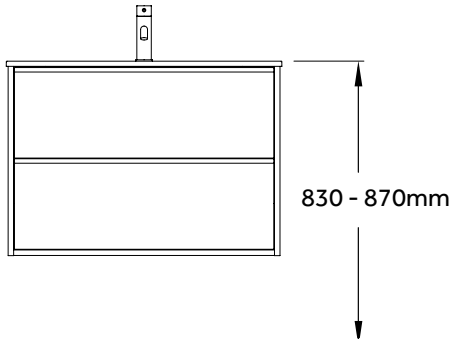

The furniture should be fixed to the walls at a sufficient distance from the bath or shower enclosure to prevent water and soap splashed on the surface. The recommended hanging heights of the cabinets are given in drawing ***. Furniture must be mounted on structures or materials that can withstand the weight and intensive use of the item. It is essential to choose the appropriate fasteners for the wall material.

IMPORTANT: Use caution when assembling and installing the product. Any strong mechanical impact can damage the painted or laminated surface, and the electrical part. Place the product and its parts on clean and soft surfaces during work. Only use the fittings that come with the furniture for assembly, otherwise you may damage the product. The exception is when hanging the furniture on the wall, in which case you need to choose the right fasteners for the wall material.

WASHBASIN INSTALLATION

After hanging the cabinet (before placing the washbasin) coat the upper part of the cabinet in contact with the sink with silicone or other sealant to protect it from the moisture. When the washbasin is placed on the cabinet, the gap between the washbasin and the wall must be coated with a moisture-resistant sealant, the residue of which must be cleaned off immediately. When installing the facades, it is important to adjust the spacing so that it does not touch the ceramics of the basin.

BATHROOM FURNITURE MAINTENANCE, CONDITIONS OF USE

Furniture must be hung in heated and well-ventilated rooms. Ambient temperatures: +5C to +35C, relative humidity 30-75%. Furniture must not come into contact with heating equipment.

Furniture must be protected from:

- Direct exposure to water and steam: the premises must be dry and well ventilated
- Mechanical effects: avoid damaging furniture surfaces with sharp objects and avoid knocks

Fluid exposure: If liquid gets on the furniture, they must be wiped off immediately. Many concentrated cosmetic products can damage the surface of the product.

DAILY MAINTENANCE

All bathroom furniture is easy to maintain. Do not use abrasive substances or cleaning agents with thinners for cleaning, as these can damage the surface. It is recommended to remove dirt from the furniture with a damp microfibre cloth and to wipe the dampened surface thoroughly with a clean, dry cloth. Only use products that are free of abrasive.

Warranty Obligations

The Warranty is limited to the value of the product and does not cover the costs of installation, dismantling, transport and replacement.

The warranty does not cover:

- If damage is caused to the product due to improper storage, installation or use conditions, extreme temperatures, and exposure to aggressive substances (solvents, thinners, alkalis, etc)
- If at the consumer's discretion the furniture has been transformed, cut out, replaced, or otherwise modified.
- If the loss is caused by normal wear and tear such as scratches, marks, damage caused by impact, accident, transport damage after delivery of the goods.
- If the furniture is not equipped with washbasins or fittings offered by Coalbrook, except for wall mountings,

CLOAKROOM VANITY UNITS INSTALLATION

01

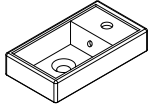
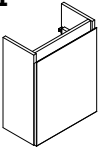

A (x1)

B (x2)

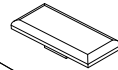
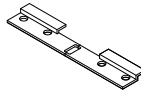

02

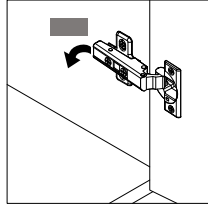
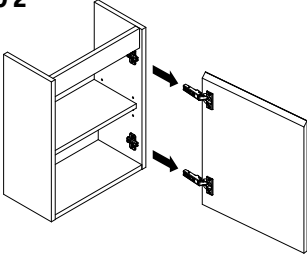

03

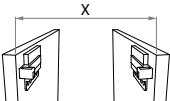

1

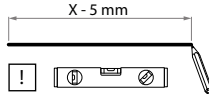

2

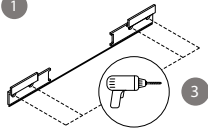

3

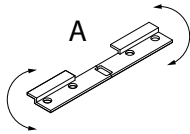
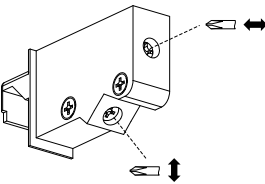

A

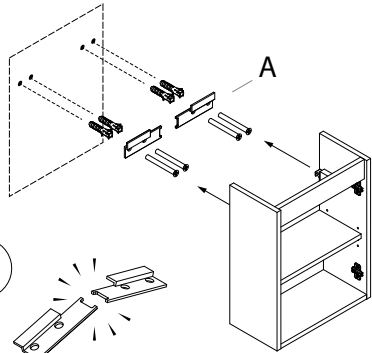

For mounting, use suitable screws for the wall material

04

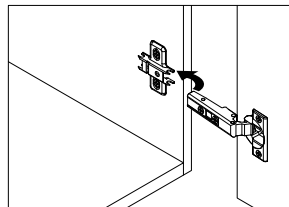
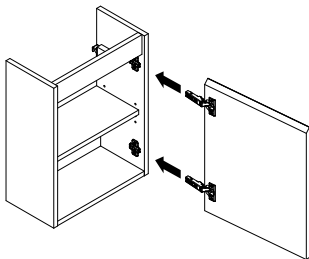

CLOAKROOM VANITY UNITS INSTALLATION

05

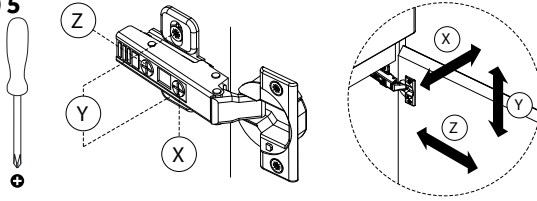

06

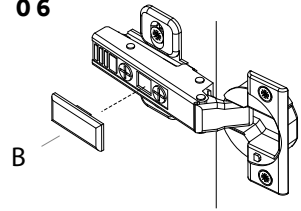

07 (A)

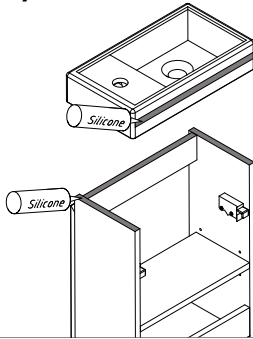

07 (B)

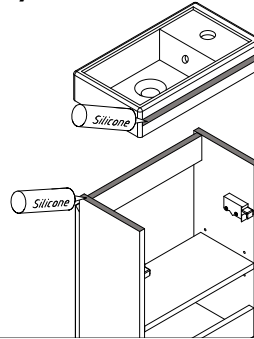

08 (A)

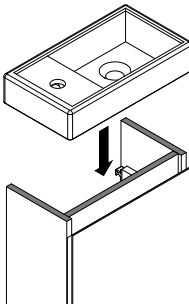

08 (B)

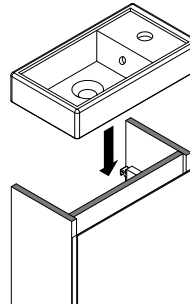

09 (A)

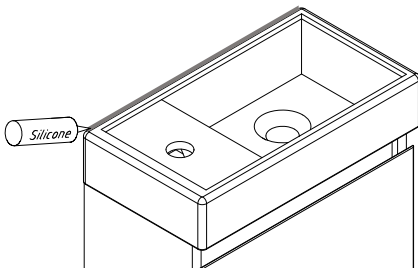

09 (B)

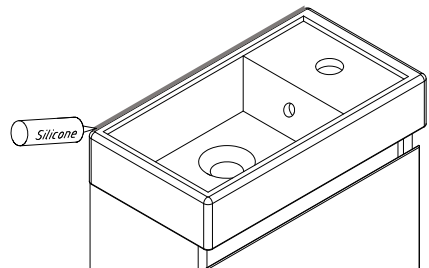

TALL UNITS INSTALLATION

01

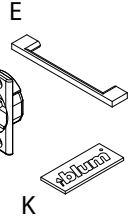
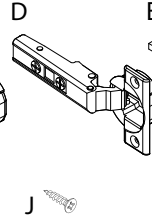
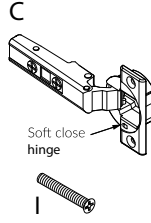
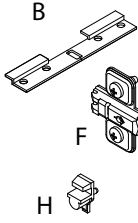
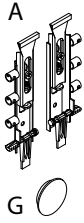
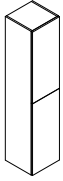

02

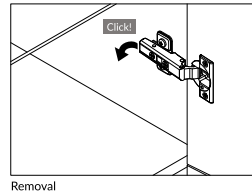
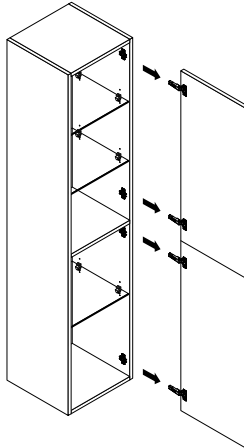
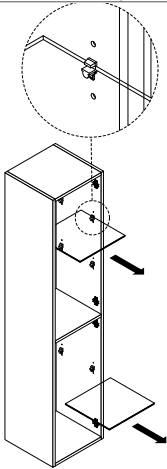

03

1

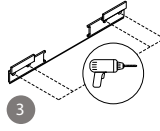
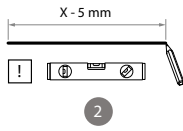
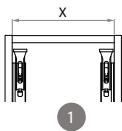

! For mounting, use suitable screws for the wall material

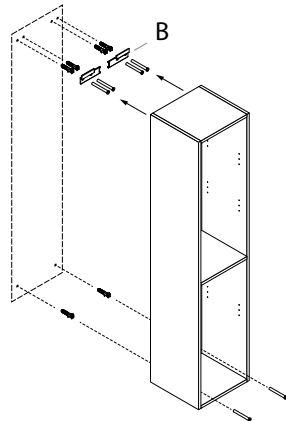
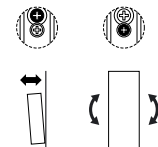
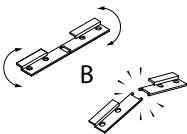
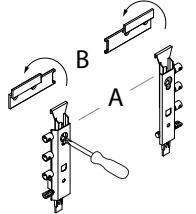
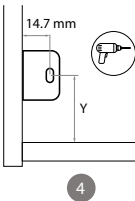

TALL UNITS INSTALLATION

04

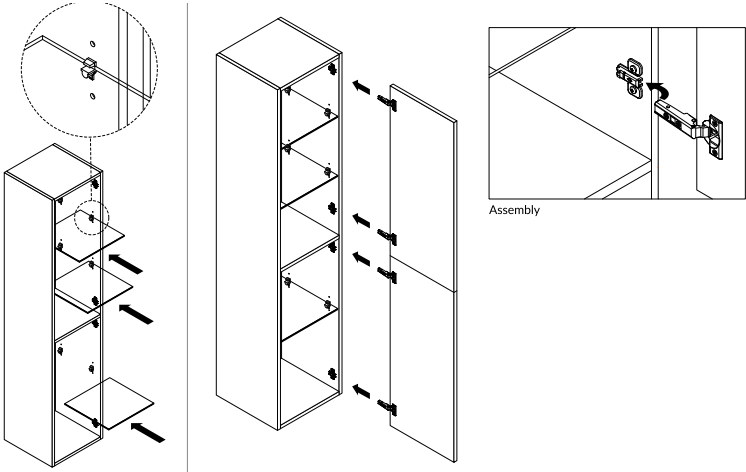

05

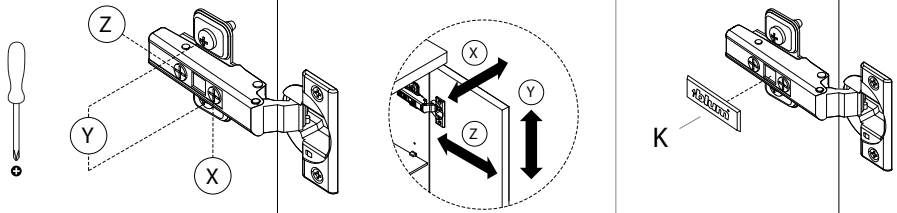

SHORT PROJECTION VANITY UNIT INSTALLATION

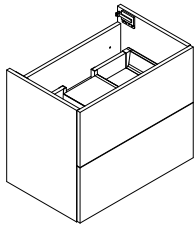

A (x1)

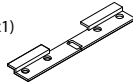

B (x4)

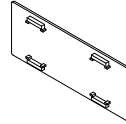

01

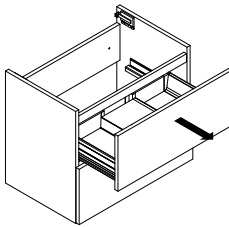

100%

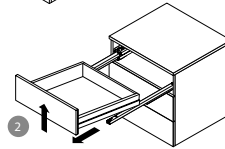
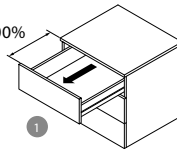

02

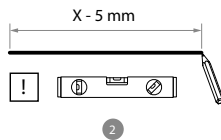
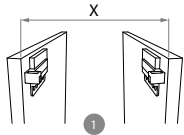

For mounting, use suitable screws for the wall material

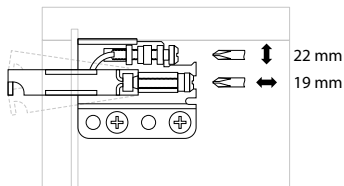
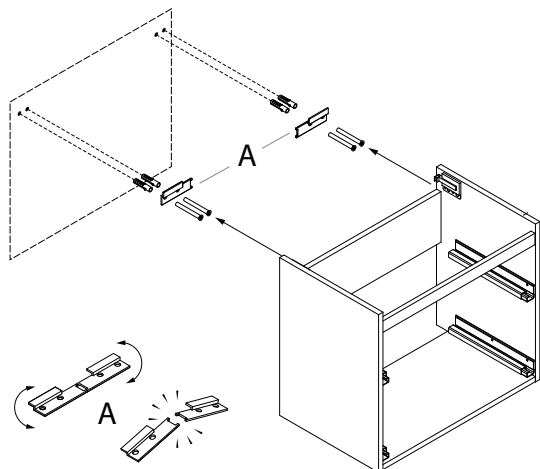
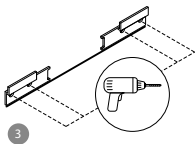

SHORT PROJECTION VANITY UNIT INSTALLATION

03

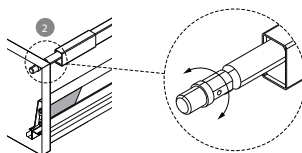
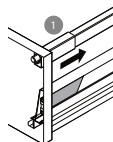
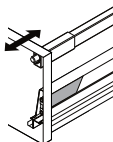
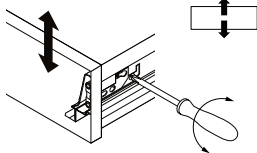
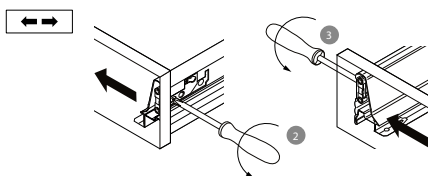
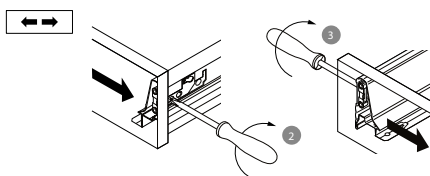
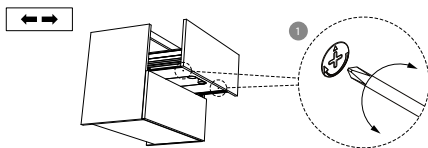
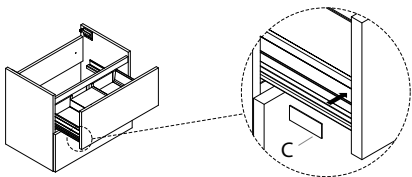
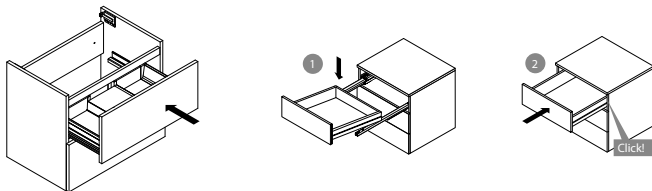

04

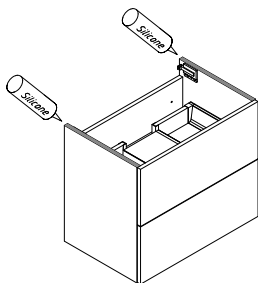

05

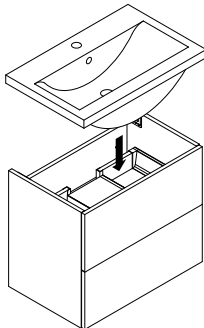

06

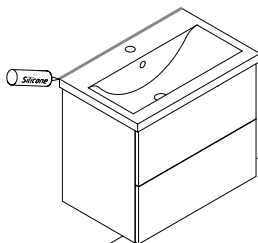

600MM-1200MM VANITY UNIT INSTALLATION

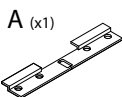
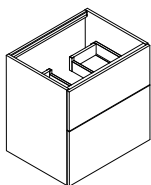

01

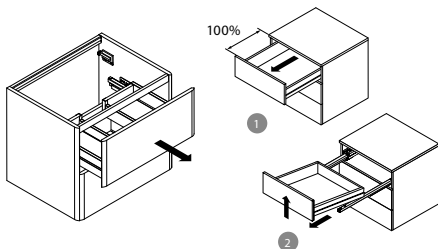

02

! For mounting, use suitable screws for the wall material

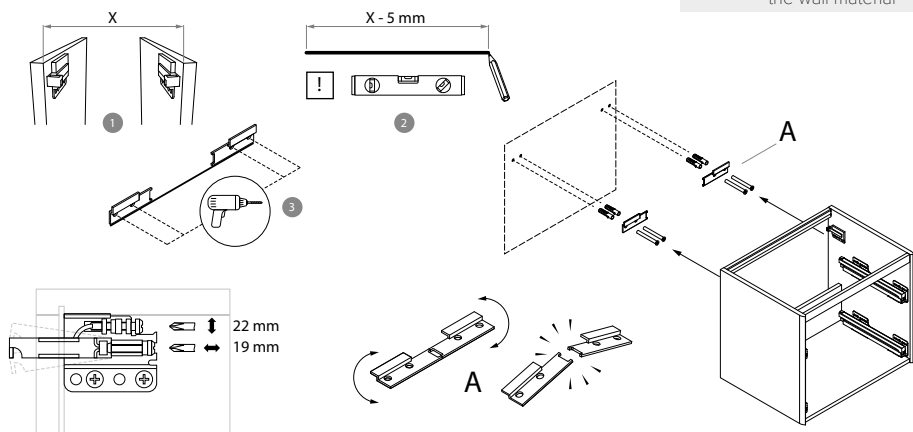

03

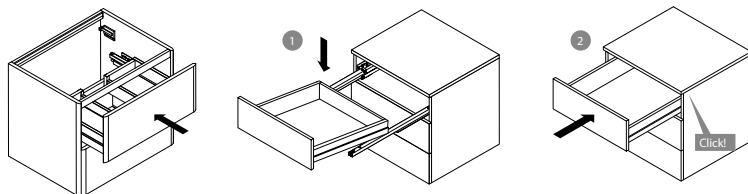

600MM-1200MM VANITY UNIT INSTALLATION

04

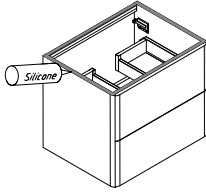

05

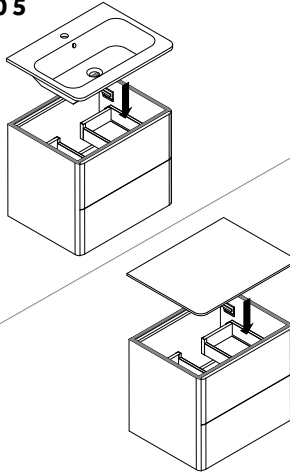

06

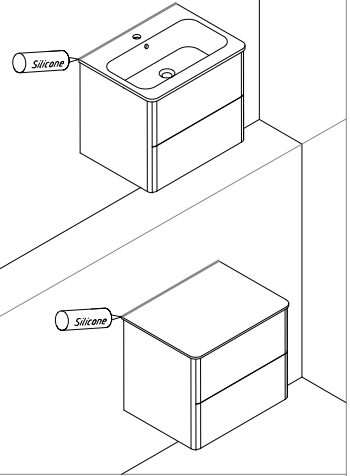

Adjustment

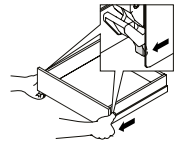
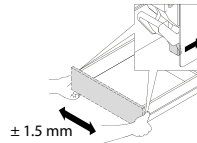
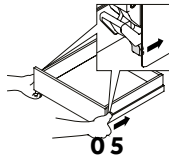
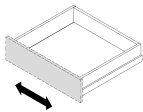
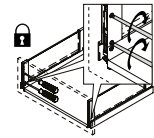
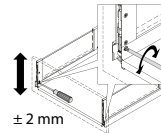
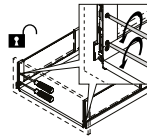
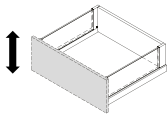
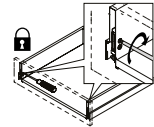
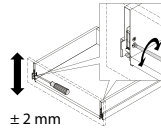
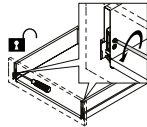
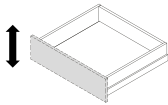

Installation

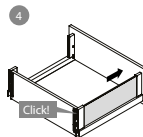
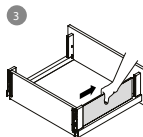
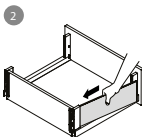
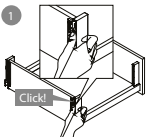

Dismounting

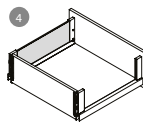
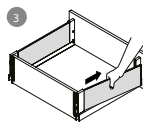
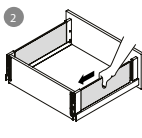
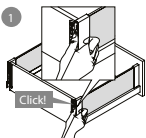

Tilt angle adjustment

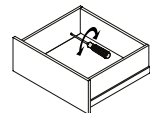
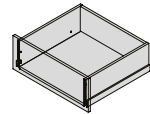

LED STRIP LIGHTING INSTALLATION

01

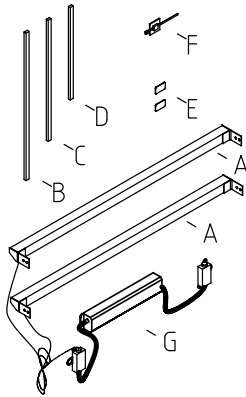

All electrical work should be carried out only by a suitably qualified and competent person, in strict accordance with national safety regulations.

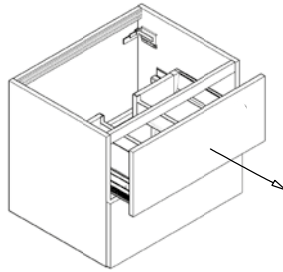

02

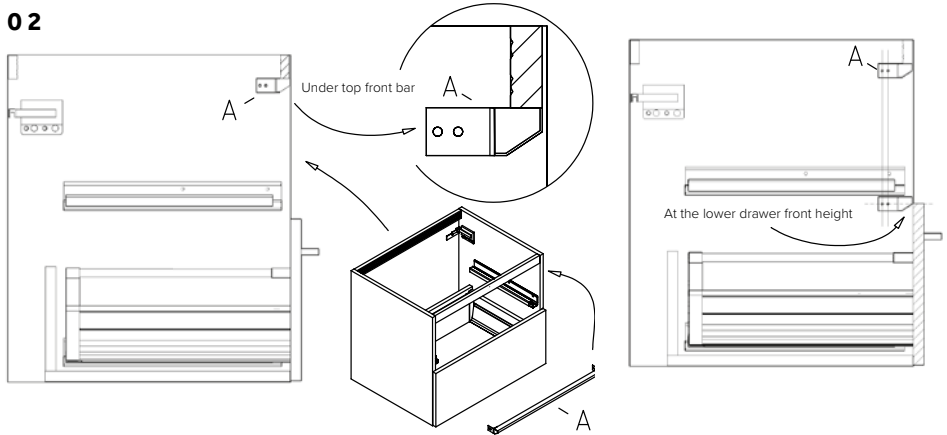

03

Other variants

In a variant of top and middle horizontal bar, position LED profile flush under the bars.

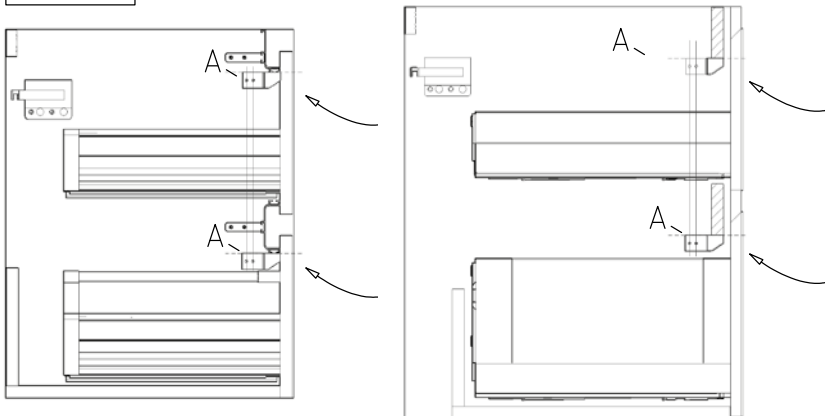

LED STRIP LIGHTING INSTALLATION

04

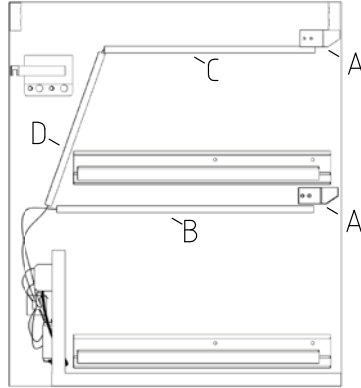
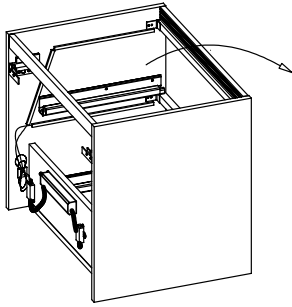

06

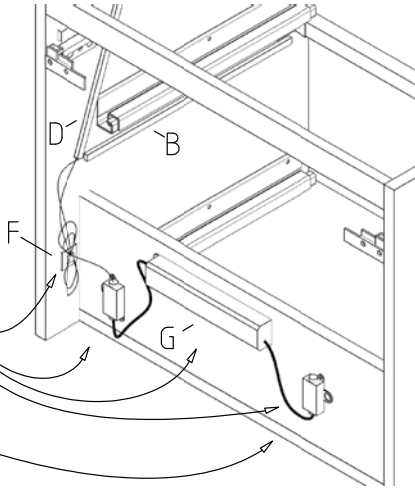
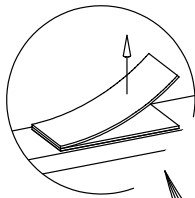

INPUT ~230 V wiring
Brown - Load
Blue - Neutral

05

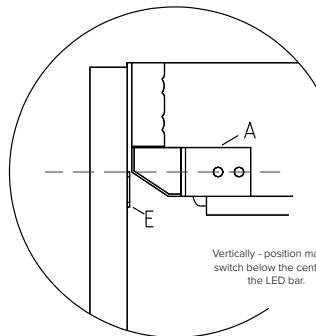
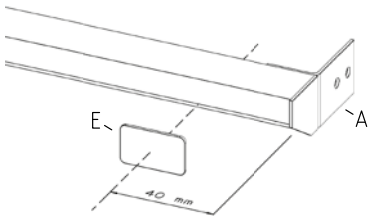

Vertically - position magnet switch below the center of the LED bar.

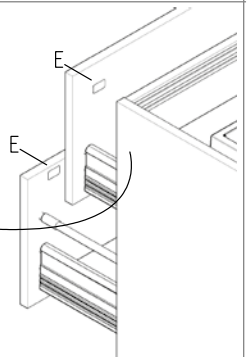

Horizontally - position magnet switch from the right side of the LED bar end.



COALBROOK

Whilst every effort is made to ensure the accuracy of these, they are subject to change without notice as part of the company's product development process.

The use of trademarks, product design and artwork is subject to licence or agreement.

The design registrations, trademark registrations and copyrights are protected by law and the use or reproduction outside the terms of an agreement is prohibited.

The right to modify designs and dimensions is reserved. E & O.E.

V1.0226

COALBROOK

www.coalbrookuk.co.uk | info@coalbrookuk.co.uk