

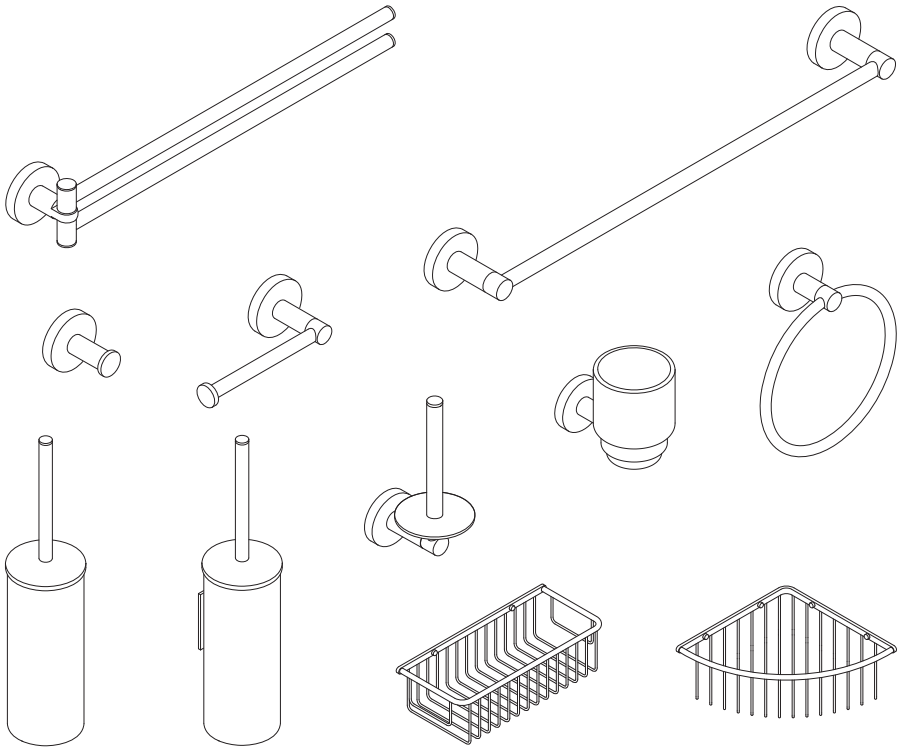

COALBROOK



ACCESSORIES INSTALLATION

DO7000 - 7010

HOLDER INSTALLATION

DO7000

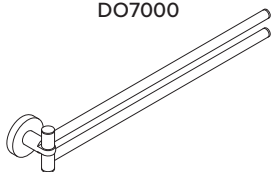

DO7005

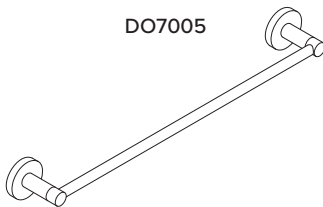

DO7003



DO7002

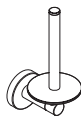

DO7010



DO7008



DO7006

1

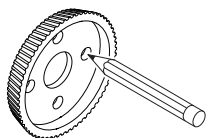

2

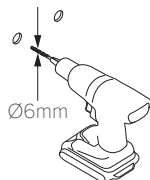

3

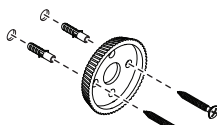

4

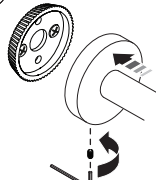

BASKET INSTALLATION

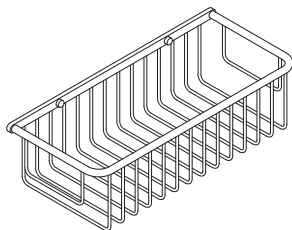

DO7004

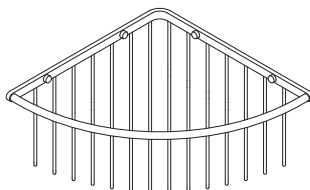

DO7007

1

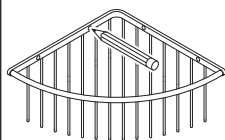

2

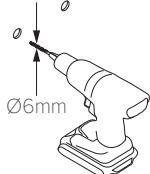

3

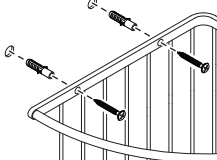

4

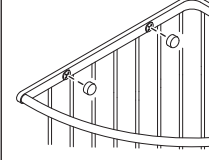

COALBROOK

www.coalbrookuk.co.uk | info@coalbrookuk.co.uk

TOILET BRUSH HOLDER INSTALLATION

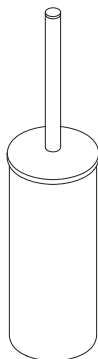

DO7001

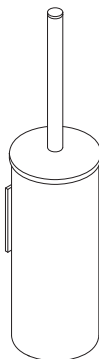

DO7009 - See below

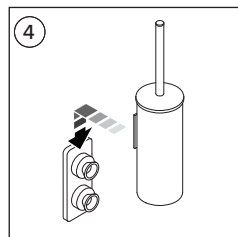
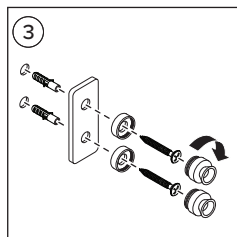
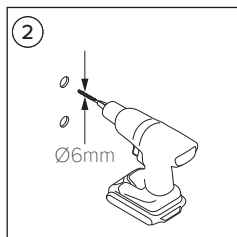
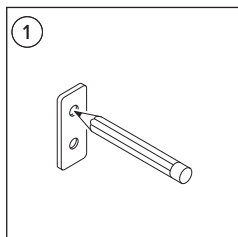

COALBROOK



COALBROOK

Whilst every effort is made to ensure the accuracy of these, they are subject to change without notice as part of the company's product development process. The use of trademarks, product design and artwork is subject to licence or agreement. The design registrations, trademark registrations and copyrights are protected by law and the use or reproduction outside the terms of an agreement is prohibited.

The right to modify designs and dimensions is reserved. E & O.E.

V2.0524

COALBROOK

www.coalbrookuk.co.uk | info@coalbrookuk.co.uk